



McIntosh Laboratory, Inc. 2 Chambers Street Binghamton, New York 13903-2699 Phone: 607-723-3512 [www.mcintoshlabs.com](http://www.mcintoshlabs.com)

MHA150  
Headphone Amplifier  
Owner's Manual



The lightning flash with arrowhead, within an equilateral triangle, is intended to alert the user to the presence of uninsulated "dangerous voltage" within the product's enclosure that may be of sufficient magnitude to constitute a risk of electric shock to persons.

**WARNING - TO REDUCE RISK OF FIRE OR ELECTRICAL SHOCK, DO NOT EXPOSE THIS EQUIPMENT TO RAIN OR MOISTURE.**

## IMPORTANT SAFETY INSTRUCTIONS!

**PLEASE READ THEM BEFORE OPERATING THIS EQUIPMENT.**

1. Read these instructions.
2. Keep these instructions.
3. Heed all warnings.
4. Follow all instructions.
5. Do not use this apparatus near water.
6. Clean only with a dry cloth.
7. Do not block any ventilation openings. Install in accordance with the manufacturer's instructions.
8. Do not install near any heat sources such as radiators, heat registers, stoves, or other apparatus (including amplifiers) that produce heat.
9. Do not defeat the safety purpose of the polarized or grounding-type plug. A polarized plug has two blades with one wider than the other. A grounding type plug has two blades and a third grounding prong. The wide blade or the third prong are provided for your safety. If the provided plug does not fit into your outlet, consult an electrician for replacement of the obsolete outlet.
10. Protect the power cord from being walked on or pinched particularly at plugs, convenience receptacles, and the point where they exit from the apparatus.
11. Only use attachments/accessories specified by the manufacturer.
12. Use only with the cart, stand, tripod, bracket, or table specified by the manufacturer, or sold with the apparatus. When a cart is used, use



**ATTENTION:**  
RISQUE DE CHOC ELECTRIQUE - NE PAS OUVRIR  
**NO USER-SERVICEABLE PARTS INSIDE. REFER SERVICING TO QUALIFIED PERSONNEL.**

- caution when moving the cart/apparatus combination to avoid injury from tip-over.
13. Unplug this apparatus during lightning storms or when unused for long periods of time.
  14. Refer all servicing to qualified service personnel. Servicing is required when the apparatus has been damaged in any way, such as power-supply cord or plug is damaged, liquid has been spilled or objects have fallen into the apparatus, the apparatus has been exposed to rain or moisture, does not operate normally, or has been dropped.
  15. Do not expose this equipment to dripping or splashing and ensure that no objects filled with liquids, such as vases, are placed on the equipment.  
Ne pas exposer cet appareil à des éclaboussures ou gouttelettes d'un liquide. Aucun objet remplie de liquide comme par exemple un vase ne doit être placé sur l'appareil.
  16. If this equipment is supplied with a power supply cord only, the mains plug of the power supply cord shall remain readily operable. To completely disconnect this equipment from the a.c. mains remove the plug from the a.c. receptacle.  
Si l'équipement est uniquement alimenté par un cordon d'alimentation, la fiche du cordon d'alimentation doit demeurer aisément accessible. Pour déconnecter complètement l'équipement du réseau d'alimentation, déconnecter la fiche du cordon d'alimentation de la prise murale.

The exclamation point within an equilateral triangle is intended to alert the user to the presence of important operating and maintenance (servicing) instructions in the literature accompanying the appliance.

**To prevent the risk of electric shock, do not remove cover or back. No user-serviceable parts inside.**

17. If this equipment is supplied with AC /DC Adapter with separate power supply cord or the AC/DC Adapter plugging directly into an a.c. receptacle, they shall remain readily operable. To completely disconnect this equipment from the a.c. mains remove the AC /DC Adapter mains power supply cord from the a.c. receptacle or remove the AC /DC Adapter when it is directly plugged into the a.c. receptacle.  
Si l'équipement est alimenté par un adaptateur AC/DC munis d'un cordon d'alimentation ou un adaptateur AC/DC qui est alimenté directement à la prise murale, ils doivent demeurer aisément accessibles. Pour déconnecter complètement l'équipement du réseau d'alimentation, déconnecter l'adaptateur AC/DC de la prise murale ou déconnecter le cordon d'alimentation de l'adaptateur AC/DC de la prise murale.
18. **WARNING:** Do not expose batteries or battery pack to excessive heat such as sunshine, fire or the like.  
**AVERTISSEMENT:** Les batteries ou bloc de batteries ne doivent pas être exposées à une chaleur excessive telle que celle du soleil, feu ou autre source de chaleur similaire.
19. **CAUTION:** danger of explosion if battery is incorrectly replaced. Replace only with the same or equivalent type.  
**ATTENTION:** danger d'explosion si la pile n'est pas remplacée correctement. Ne remplacer que par le même type ou un type équivalent.
20. Connect mains power supply cord only to a mains socket outlet with a protective earthing connection.

## Thank You

Your decision to own this McIntosh MHA150 Headphone Amplifier ranks you at the very top among discriminating music listeners. You now have the best. The McIntosh dedication to precision performance assures many years of musical enjoyment. Please take a short time to read the information in this manual. We want you to be as familiar as possible with all the features and functions of your new McIntosh.

## Please Take A Moment

The serial number, purchase date and McIntosh Dealer name are important to you for possible insurance claim or future service. The spaces below have been provided for you to record that information:

Serial Number: \_\_\_\_\_

Purchase Date: \_\_\_\_\_

Dealer Name: \_\_\_\_\_

## Technical Assistance

If at any time you have questions about your McIntosh product, contact your McIntosh Dealer who is familiar with your McIntosh equipment and any other brands that may be part of your system. If you or your Dealer wish additional help concerning a suspected problem, you can receive technical assistance for all McIntosh products at:

McIntosh Laboratory, Inc.  
2 Chambers Street  
Binghamton, New York 13903  
Phone: 607-723-3512  
Fax: 607-724-0549

Copyright 2016 © by McIntosh Laboratory, Inc.

## Customer Service

If it is determined that your McIntosh product is in need of repair, you can return it to your Dealer. You can also return it to the McIntosh Laboratory Service Department. For assistance on factory repair return procedure, contact the McIntosh Service Department at:

McIntosh Laboratory, Inc.  
2 Chambers Street  
Binghamton, New York 13903  
Phone: 607-723-3515  
Fax: 607-723-1917

## Table of Contents

Safety Instructions.....	2
Thank You and Please Take a Moment .....	3
Technical Assistance and Customer Service.....	3
Table of Contents .....	3
General Information .....	4
Connector and Cable Information .....	4
Introduction .....	5
Performance Features .....	5
Dimensions .....	6
Installation .....	7
<b>Connections:</b>	
Rear Panel Connections.....	8
Connecting Components and Optional Loudspeakers.....	10-11
System Thru Connections .....	12
External Power Amplifier Connections .....	13
<b>Remote Control and Front Panel:</b>	
Remote Control Push-buttons .....	14
How to use the Remote Control.....	15
Front Panel Displays, Controls, Push-button and Jack .....	16
<b>Setup Mode:</b>	
How to Operate the Setup Mode .....	17
Default Settings .....	17
Firmware Version .....	18

## Setup Mode: con't

Input Renaming .....	18
Speaker Mode .....	19
Subwoofer Mode.....	19
Power Mode.....	19
Remote Control.....	20
Volume Guard.....	20
Factory Reset.....	20

## Operation:

How to Operate the MHA150.....	21
Power On/Off .....	21
Source Selection .....	21
Volume Control .....	21

## Trim Functions:

Trim Functions Introduction.....	21
Bass Boost.....	21
Balance.....	22
Trim Level.....	22
Mono/Stereo Mode .....	22
Meter Lights.....	23
Display .....	23
Display Information Mode.....	23

Mute.....	23
Headphone Jack, Headphone HXD™ .....	24
Output Control.....	24
Profile Mode.....	24-26
Power Output Meters and Power Guard.....	26
Using a Separate Power Amplifier.....	26
Optical and Coaxial Digital Inputs .....	27
USB Input Operation and Driver Installation .....	27
Installing the Software .....	27-28
USB Audio Driver Operation and Reset of Microprocessors .....	29

Specifications.....	30
---------------------	----

Packing Instructions .....	31
----------------------------	----

## General Information

1. For additional connection information, refer to the owner's manual(s) for any component(s) connected to the MHA150.
2. Apply AC Power to the MHA150 and other McIntosh Component(s) only after all the system components are connected together. Failure to do so may cause a malfunction of system operations as the Microprocessor's Circuitry inside the components is active when AC Power is applied.
3. **The MHA150 includes an Auto Off Power Save Feature and the default setting is enabled.** For additional information including how to disable it, refer to page 19.
4. When Power Amplifier Protection Circuitry of the MHA150 has activated, the Front Panel Power Guard LEDs are illuminated continuously and the sound will be muted.
5. If the Power Transformer has overheated due to improper ventilation and/or high ambient operating temperature, AC Power is removed from the MHA150. Normal operation will resume when the operating temperature is in a safe range again.
6. The Remote Control supplied with the MHA150 is also capable of operating other McIntosh Components. These other components may include Pre-amplifiers, A/V Control Centers, Integrated Amplifiers, Source Components and Integrated Audio Systems. There is a chance the MHA150 and one of these other components may both respond to a command issued by the MHA150 Remote Control or the Remote Control supplied with the other component. This could affect operations such as Volume Up/Down and Power On/Off. Many of these other McIntosh components have the ability to utilize what is known as "Alternate Codes" to prevent them from responding to commands issued

by the MHA150 Remote Control. For additional information refer to the Owner's Manual supplied with the other McIntosh Component and look in the "Setup Section - Remote Control Codes" of the manual. In those rare instances where using the "Alternate Codes" is not possible, the Remote Control Sensor on the MHA150 can be switched Off and the Front Panel Controls can be used for operation instead of using the Remote Control. Refer to page 20.

7. For the best performance and safety, it is important to always match the impedance of the Loudspeaker to the Power Amplifier connections. Refer to pages 10 and 11.

*Note: The impedance of a Loudspeaker actually varies as the Loudspeaker reproduces different frequencies. As a result, the nominal impedance rating of the Loudspeaker (usually measured at a midrange frequency) might not always agree with the impedance of the Loudspeaker at low frequencies where the greatest amount of power is required. Contact the Loudspeaker Manufacturer for additional information about the actual impedance of the Loudspeaker before connecting it to the McIntosh MHA150.*

8. Sound Intensity is measured in units called Decibels and "dB" is the abbreviation.
9. When discarding the unit, comply with local rules or regulations. Batteries should never be thrown away or incinerated but disposed of in accordance with the local regulations concerning battery disposal.
10. For additional information on the MHA150 and other McIntosh Products please visit the McIntosh Web Site at [www.mcintoshlabs.com](http://www.mcintoshlabs.com).

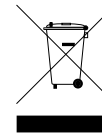

## Connector and Cable Information

### XLR Connectors

Below is the Pin configuration for the XLR Balanced Input Connectors on the MHA150. Refer to the diagram for connection:

- PIN 1: Shield/Ground
- PIN 2: + Input
- PIN 3: - Input

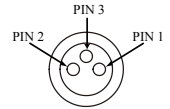

### Power Control Connectors

The Power Control Input Jack receives Power On/Off Signals (+12 volt/0 volt) when connected to other McIntosh Components. The Power Control Output Jack sends Power On/Off Signals (+12 volt/0 volt) when connected to other McIntosh Components. An additional connection is for controlling the illumination of the Power Output Meters on McIntosh Power Amplifiers. A 3.5mm stereo mini phone plug is used for connection to the Power Control Jacks.

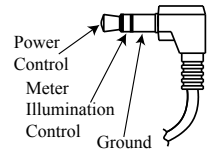

### Output Terminal Connector

When cables with spade lugs are used for Loudspeaker Connection, the spade lugs need an opening of at least 3/10 inch (7.6mm).

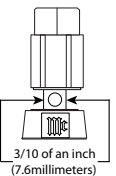

## Introduction

Now you can take advantage of traditional McIntosh standards of excellence in the MHA150 Headphone Amplifier. The Power Amplifier section of the MHA150 will drive Headphones or a pair of quality Loudspeakers to a high level of performance.

The flexible Preamplifier section provides connections for various input sources, including Digital sources and music streaming from the Internet via an USB Computer connection.

The MHA150 reproduction is sonically transparent and absolutely accurate. The McIntosh Sound is “The Sound of the Music Itself.”

## Performance Features

### • Power Output

The MHA150 consists of a 50 watts per channel stereo Power Amplifier with less than 0.005% distortion. The McIntosh MHA150 is designed for connection of a single 8 ohm Loudspeaker per channel. The Power Amplifier uses ThermalTrak<sup>1</sup> Output Transistors for lower distortion and cool operation.

### • Autoformer Designed for Headphones

The MHA150 Amplifier uses a specially designed Autoformer for Headphones. There are three selectable impedances ranges, allowing connection of Headphones from 8 ohms thru 600 ohms.

### • HXD<sup>®</sup> for Headphones

The MHA150 Headphone Crossfeed Director Circuitry (HXD<sup>®</sup>) improves the sound localization for Headphone Listening. HXD<sup>™</sup> restores the directionality component of the spatial sound stage normally heard with Loudspeaker listening.

<sup>1</sup> ThermalTrak<sup>™</sup> and ON Semiconductor are trademarks of Semiconductor Components Industries, LLC

HXD<sup>®</sup> is a registered trademark of McIntosh Laboratory, Inc.

### • Automatic Output Switching

The MHA150 has a Front Panel one-quarter inch Headphone Jack for private listening. Loudspeaker Listening is automatically switched Off when Headphones are connected.

### • Four Forms of Protection

McIntosh Sentry Monitor Protection Circuits ensure a long and trouble free operating life. It also protects the Headphones in the event of an impedance mismatch. Thermal Protection guards against overheating and Direct Current Detection Protects both Headphones and Loudspeakers.

### • Power Guard

The patented McIntosh Power Guard circuit prevents amplifier clipping and protects your valuable Headphones and Loudspeakers.

### • Electronic Switching for Analog Inputs

The Preamplifier uses Logic Circuits controlling Electromagnetic Switches for reliable, noiseless, distortion free switching. There is a Balanced and Unbalanced Input for connection of source components.

### • Digital Audio Inputs

The MHA150 has four Digital Audio Inputs to decode PCM Signals. When the Coaxial, Optical and MCT Inputs receive a PCM Signal, the MHA150 upsamples the Digital Signal to 192kHz with 24Bit resolution before the Digital to Analog process begins. The Digital MCT Input Circuitry directly decodes SACD/CD signals from an external Transport component. The USB Input for streaming audio, processes Digital Signals up to 384kHz with 32Bit resolution, decodes up to DSD256 Digital Signals and DXD 24Bit with a sampling rate up to 384kHz.

### • Multifunction OLED Display

The Front Panel Display indicates source selection, volume levels, trim settings and setup functions.

### • Illuminated Meters

The Illuminated Power Output Meters on the MHA150 are peak responding, and indicate the output of the amplifier.

### • Power Control and Remote Control

The Power Control Output connection provides convenient Turn-On/Off of McIntosh Source Components.

### • Special Power Supply

The large Power Transformer, multiple large filter capacitors and regulated Power Supply ensure stable noise free operation even though the power line varies.

### • McIntosh Custom Binding Posts

McIntosh Patented gold plated output terminals deliver high current output. They accept large diameter wire and spade lugs. Banana plugs may also be used only in the United States and Canada.

### • Glass Front Panel and Super Mirror Chassis

The MHA150 has the famous McIntosh Illuminated Glass Front Panel and Stainless Steel Super Mirror Finish Chassis. This ensures the pristine beauty of the MHA150 will be retained for many years.

### • Fiber Optic Solid State Front Panel Illumination

The even Illumination of the Front Panel is accomplished by the combination of custom designed Fiber Optic Light Diffusers and extra long life Light Emitting Diodes (LEDs).

## Dimensions

The following dimensions can assist in determining the best location for your MHA150. There is additional information on the next page pertaining to installing the MHA150 into cabinets.

Front View of the MHA150

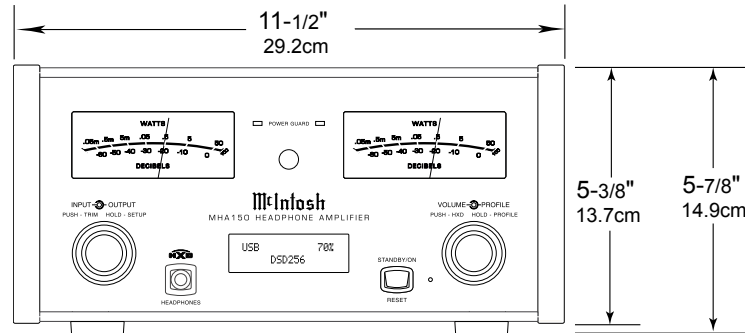

Side View of the MHA150

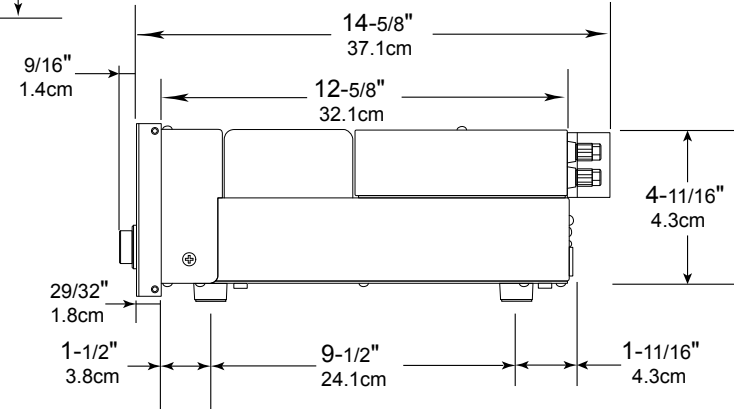

Rear View of the MHA150

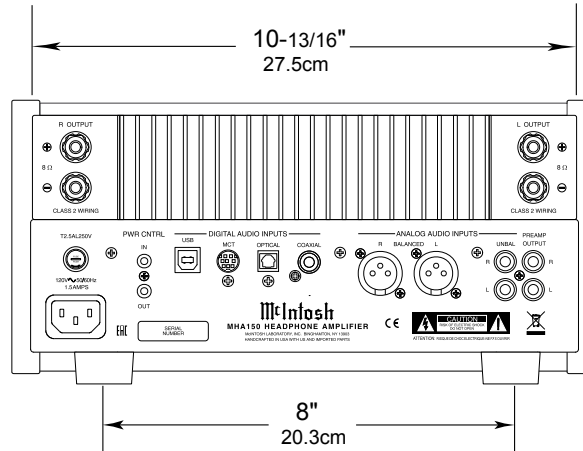

### Installation

The MHA150 Headphone Amplifier is designed to be placed upright on a table or shelf, standing on its feet. The required ventilation requirements are shown. Always provide adequate ventilation for your MHA150. Cool operation ensures the longest possible operating life for any electronic instrument. Do not install the MHA150 directly above a heat generating device, such as a Power Amplifier. Allow at least 6 inches (15.3cm) above the top, 5/8 inch (1.6cm) below the bottom and 2 inches (5.1cm) on each side of the Amplifier, so that airflow is not obstructed. Allow 19 inches (48.3cm) of depth for airflow and cable connections.

MHA150 Front View

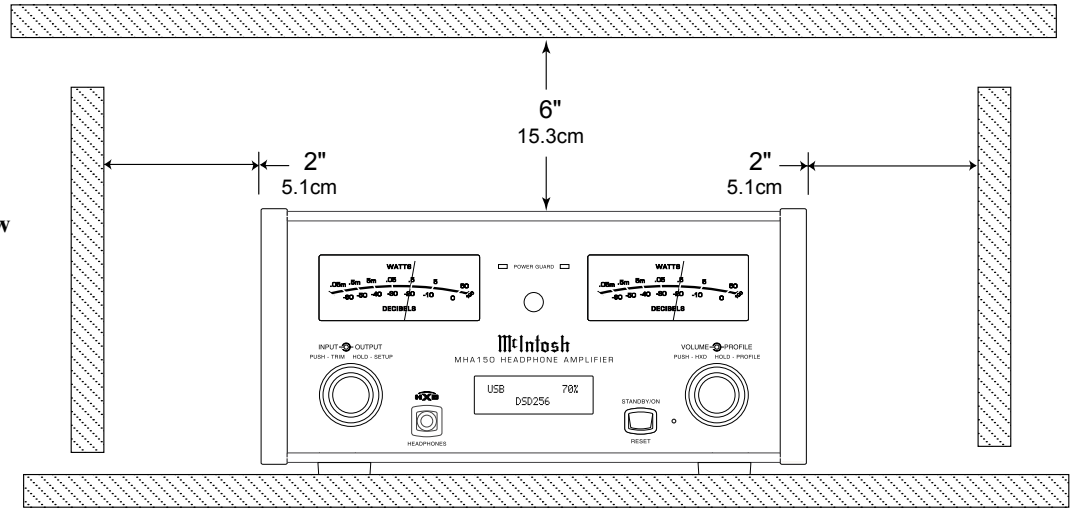

MHA150 Side View

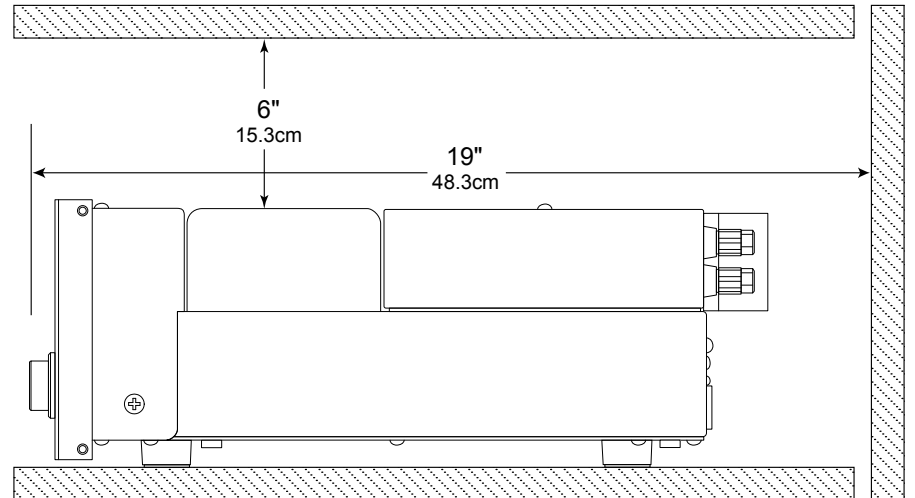



Right OUTPUT connections for an 8 ohm Loudspeaker

Left OUTPUT connections for an 8 ohm Loudspeaker

DIGITAL AUDIO INPUTS for components with Digital OPTICAL, COXIAL and MCT Digital Outputs sending digital audio signals

Main Fuse holder, refer to information on the back panel of your MHA150 to determine the correct fuse size and rating

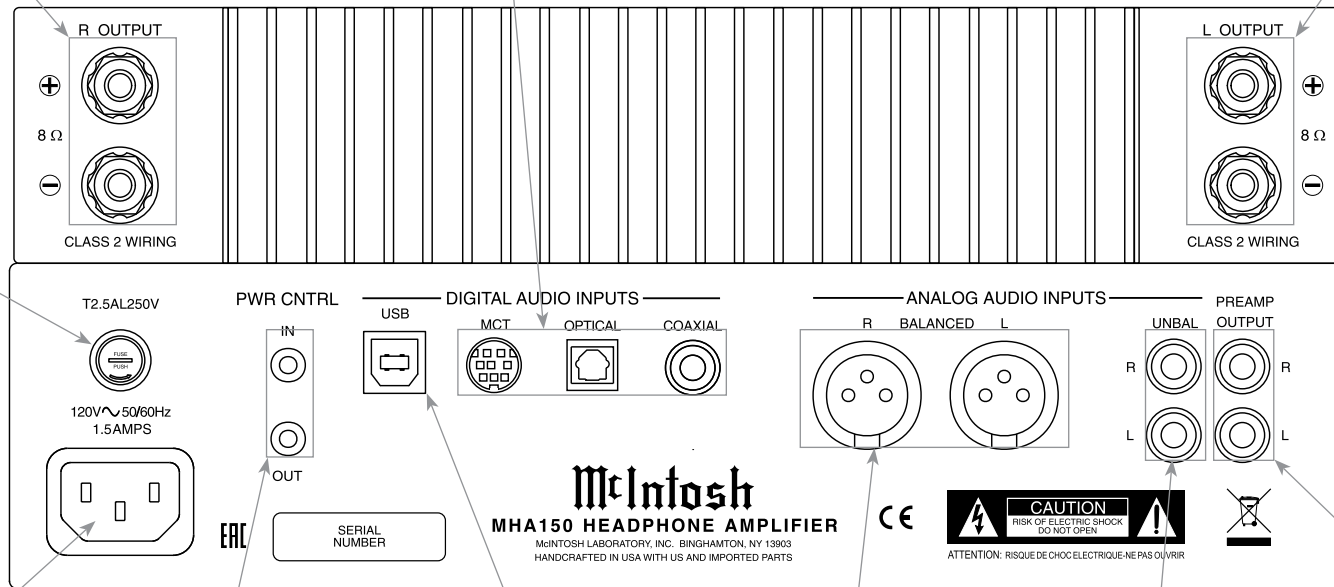

PWR CNTRL (Power Control) IN receives a turn On/Off signal from a McIntosh Component; PWR CNTRL OUT sends a turn On/Off signal to another McIntosh Component

USB Digital Audio Input for connection to a computer

BALANCED INPUTS accept high level signals from a source with a balanced output

UNBALANCED INPUTS accept high level signals from a source with an unbalanced output

PREAMP OUTPUTS send signals to an external Power Amplifier or Powered Subwoofer

Connect the MHA150 power cord to a live AC outlet. Refer to information on the back panel of your MHA150 to determine the correct voltage for your unit





## Connecting Components

The MHA150 has the ability to automatically switch power On/Off to McIntosh Source Components via the Power Control connection.

The connection instructions below, together with the MHA150 Connection Diagram on the next page is an example of a typical audio system. Your system may vary from this, however the actual components would be connected in a similar manner. For additional information refer to “Connector and Cable Information” on page 4.

*Note: When the MHA150 is being added to an existing Audio (or Audio/Video) System, please proceed to page 12. If the MHA150 will be used with an external Power Amplifier, please refer to page 13.*

### Power Control Connections:

1. Connect a Control Cable from the MHA150 PWR CTRL (Power Control) OUT Jack to the Power Control In Jack on the Tuner.
2. Connect a Control Cable from the Tuner Power Control Out Jack to the Disc Player Power Control In Jack.
3. Connect any additional McIntosh Components in a similar manner, as outlined in steps 1 thru 2.

### Optional Audio Connections:

4. Connect the Audio Cable from the MHA150 UNBAL 1 (or BALANCED) L & R connectors to the Disc Player Fixed Audio Output Jacks.
5. Connect any additional Components in a similar manner, as outlined in step 4.

### Digital Audio Connections:

6. Connect a “DIN Cable-Twisted Pair” cable (supplied with a MCT Transport) from the MHA150 DIGITAL AUDIO MCT INPUT connector to the SACD/CD Transport DIN Output connector.
7. Connect any additional Components in a similar manner, as outlined in step 6.

### Optional USB Connection:

8. Connect a USB cable with (type A to type B) connectors from the MHA150 USB Input to an available USB connector on a Computer.

## Output Terminals

When connecting the Loudspeaker Hookup Cables to the MHA150 Output Terminals please follow the steps below:

1. Rotate the top of the Output Terminal Post counterclockwise until an opening appears. Refer to figures A and B.
2. Insert the Loudspeaker hookup cable into the Output Terminal Post opening or the cable spade lug around the center post of the Output Terminal. Refer to figure C.
3. Rotate the top of the Output Terminal Post clockwise until it is finger tight. Refer to figure D.
4. Place the supplied McIntosh Wrench over the top of the Output Terminal and rotate it one quarter of a turn (90°) to secure the Loudspeaker Cable Connection. **Do not over tighten.** Refer to figure E.

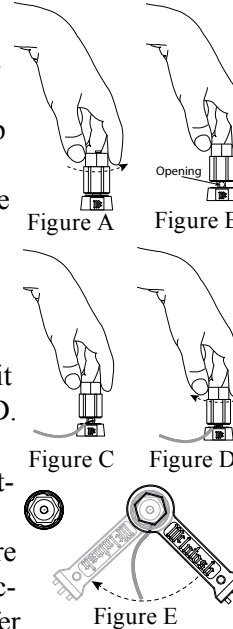

**Warning: Loudspeaker terminals are hazardous live and present a risk of electric shock. For additional instruction on making Loudspeaker Connections contact your McIntosh Dealer or McIntosh Technical Support.**

The McIntosh MHA150 Power Amplifier Circuitry is designed for a single 8 ohms Loudspeaker connected to the Right and Left Output Terminals.

The recommended cable size is shown below:

Cable Distance vs American Wire Gauge (Size)			
Loudspeaker Impedance	25 feet (7.62 meters) or less	50 feet (15.24 meters) or less	100 feet (30.48 meters) or less
8 Ohms	16AWG	14AWG	12AWG

1. Prepare the Loudspeaker Hookup Cable for attachment to the MHA150:

#### Bare wire cable ends:

Carefully remove sufficient insulation from the cable ends, refer to figures F, G & H. If the cable is stranded, carefully twist the strands together as tightly as possible.

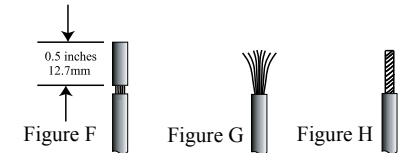

- Notes:
1. If desired, the twisted ends can be tinned with solder to keep the strands together.
  2. The prepared bare wire cable ends may be inserted into spade lug connectors.
  3. Banana plugs are for use in the United States and Canada only.

**Banana Plugs are for use in the United States and Canada only:**

2. Attach the previously prepared bare wire cable ends into the banana plugs and secure the connections. Refer to figure I.

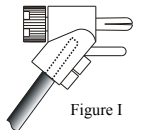

3. Rotate the Output Terminal Post clockwise until it is finger tight. Refer to figure J. Then using the McIntosh Wrench, rotate the top of the Output Terminal one quarter of a turn (90°). **Do not over tighten.** Refer to figure E.

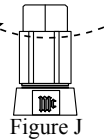

4. Referring to figure K, connect the Loudspeaker hookup cables with banana plugs into the hole at the top of the terminal to the MHA150 Negative Output Terminal and Positive Output Terminal to the Loudspeaker Terminal Connections being careful to observe the correct polarities.

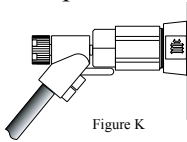

5. Connect the MHA150 power cord to an active AC outlet.

### Spade Lug or Wire Connections:

6. Connect the Loudspeaker hookup cables to the MHA150 Negative Output Terminal and Positive Output Terminal to the Loudspeaker Terminal Connections being careful to observe the correct polarities. Insert the spade lug connector or prepared section of the cable end into the terminal side access hole, and tighten the terminal cap until the cable is firmly clamped into the terminal so the lugs or wire cannot slip out. Refer to figures L and M.

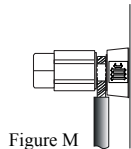
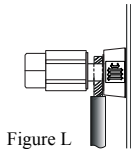

7. Connect the MHA150 power cord to an active AC outlet.

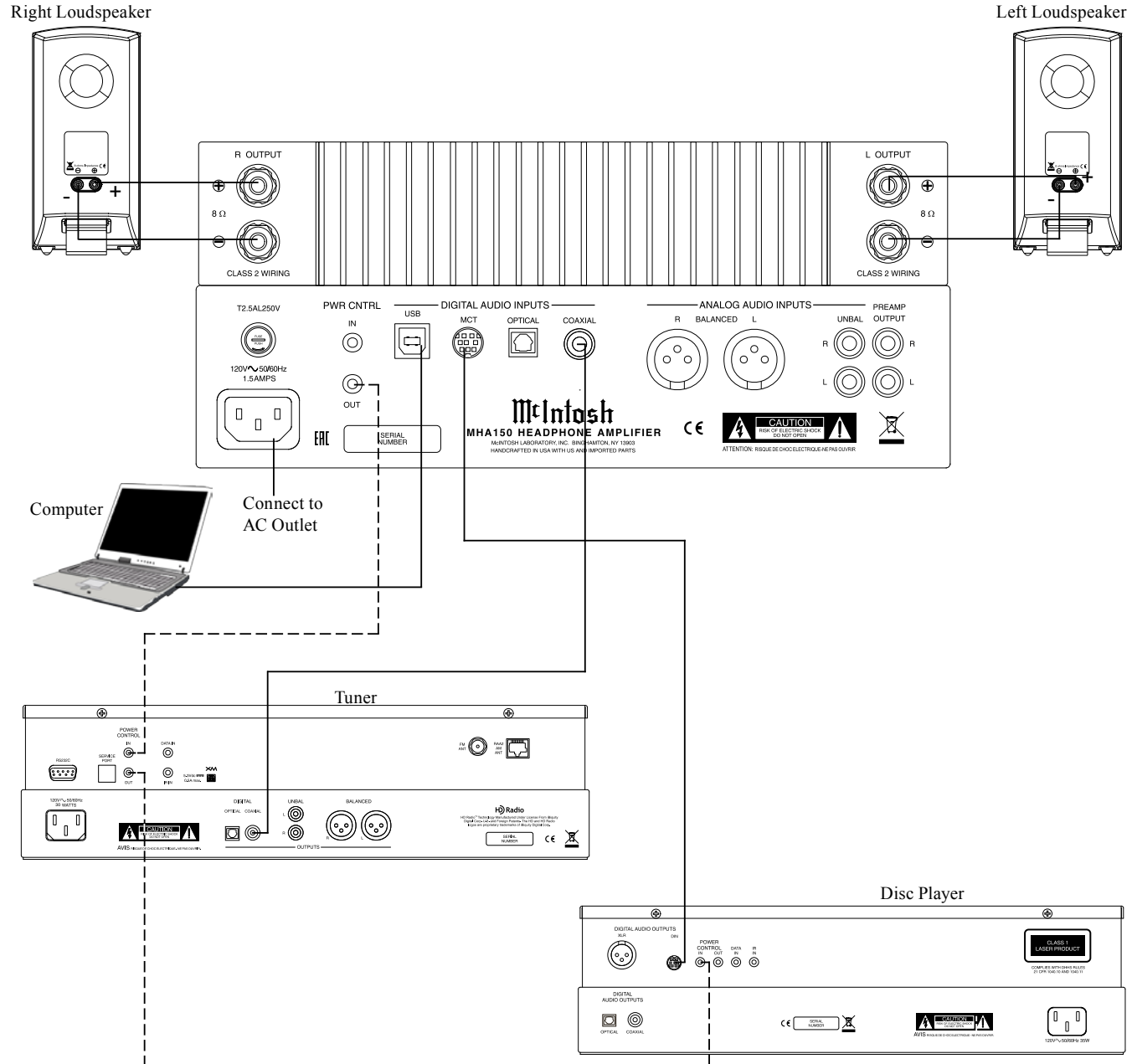

## System Thru Connections

The MHA150 can also be part of an existing Audio or Audio/Video Sound System. The MHA150 allows connection of Headphones for private listening. It can also drive Loudspeakers in a second room. The MHA150 becomes active when the Main Preamp or Audio/Video Controller is On. In the example below, the MHA150 will go On/Off when the OUTPUT 2 function of the Preamp is activated using the Power Control 2 connections.

1. Connect Audio Cables from the Preamp OUTPUT 2 Jacks to the MHA150 Analog Audio UNBAL Jacks.

*Note: The Preamp Balanced OUTPUT 2 connected to the MHA150 BALANCED Input may be used instead of the unbalanced connections.*

2. Connect a Control Cable from the Preamp POWER CONTROL OUTPUT 2 Jack to the MHA150 PWR CTRL (Power Control) IN Jack.

For additional operational information when using the System Thru Connection with the MHA150 and Main Preamp or Audio/Video Controller, refer to “System Thru Operation” on page 26.

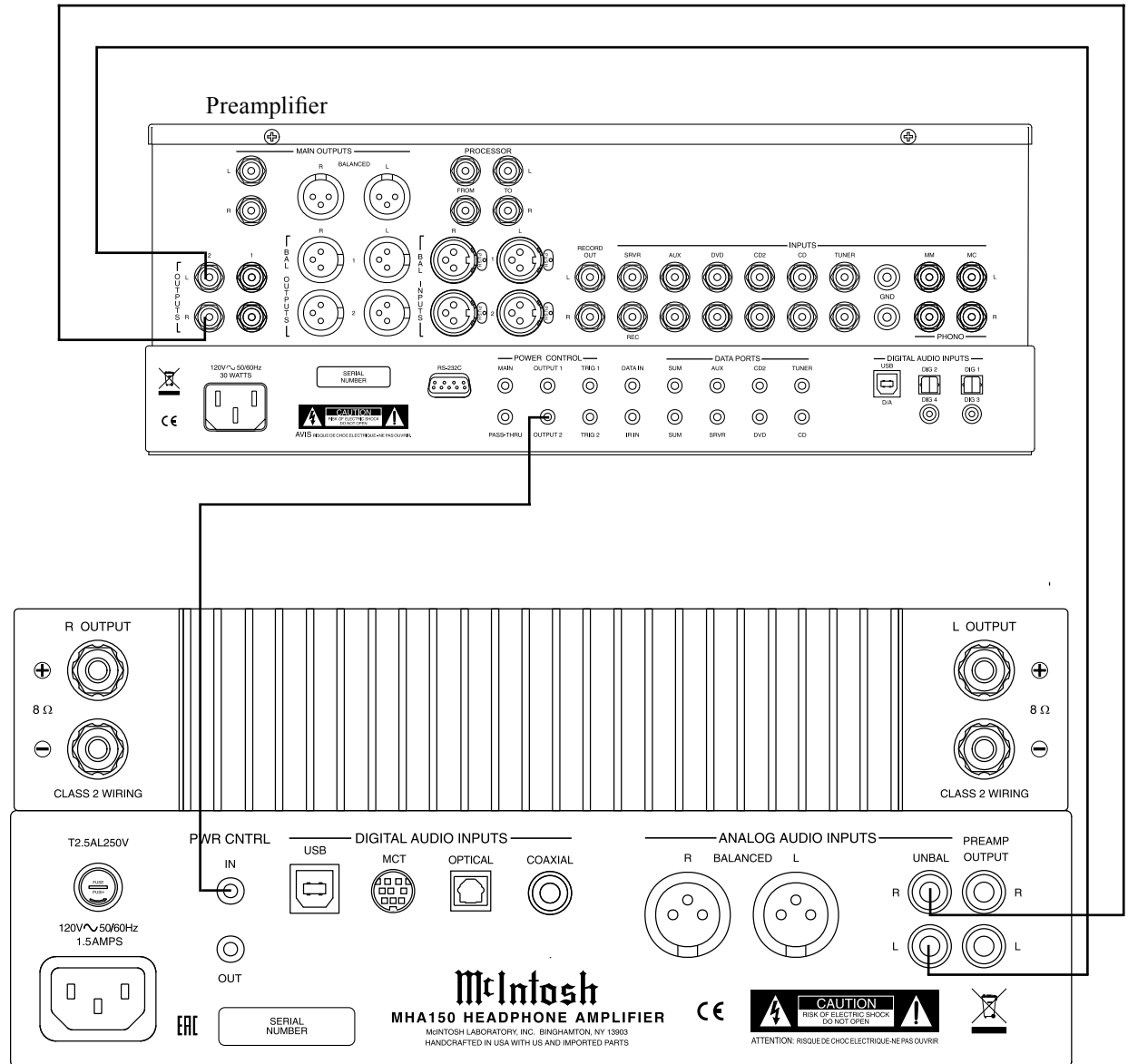

### External Power Amplifier Connections

The MHA150 has the ability to drive an External Power Amplifier. In the example below, the MHA150 automatically switches the External Power Amplifier On/Off via Power Control function.

1. Connect Audio Cables from the MHA150 PRE-AMPLIFIER OUTPUT Jacks to the External Power Amplifier IN (Left and Right) Jacks.
2. Connect a Control Cable from the MHA150 PWR CNTRL (Power Control) OUT Jack to the External Power Amplifier Power Control IN Jack.
3. Refer to page 10 for connecting other component(s) to the MHA150.
4. Refer to the External Power Amplifier Owner's Manual for connection of Loudspeakers.

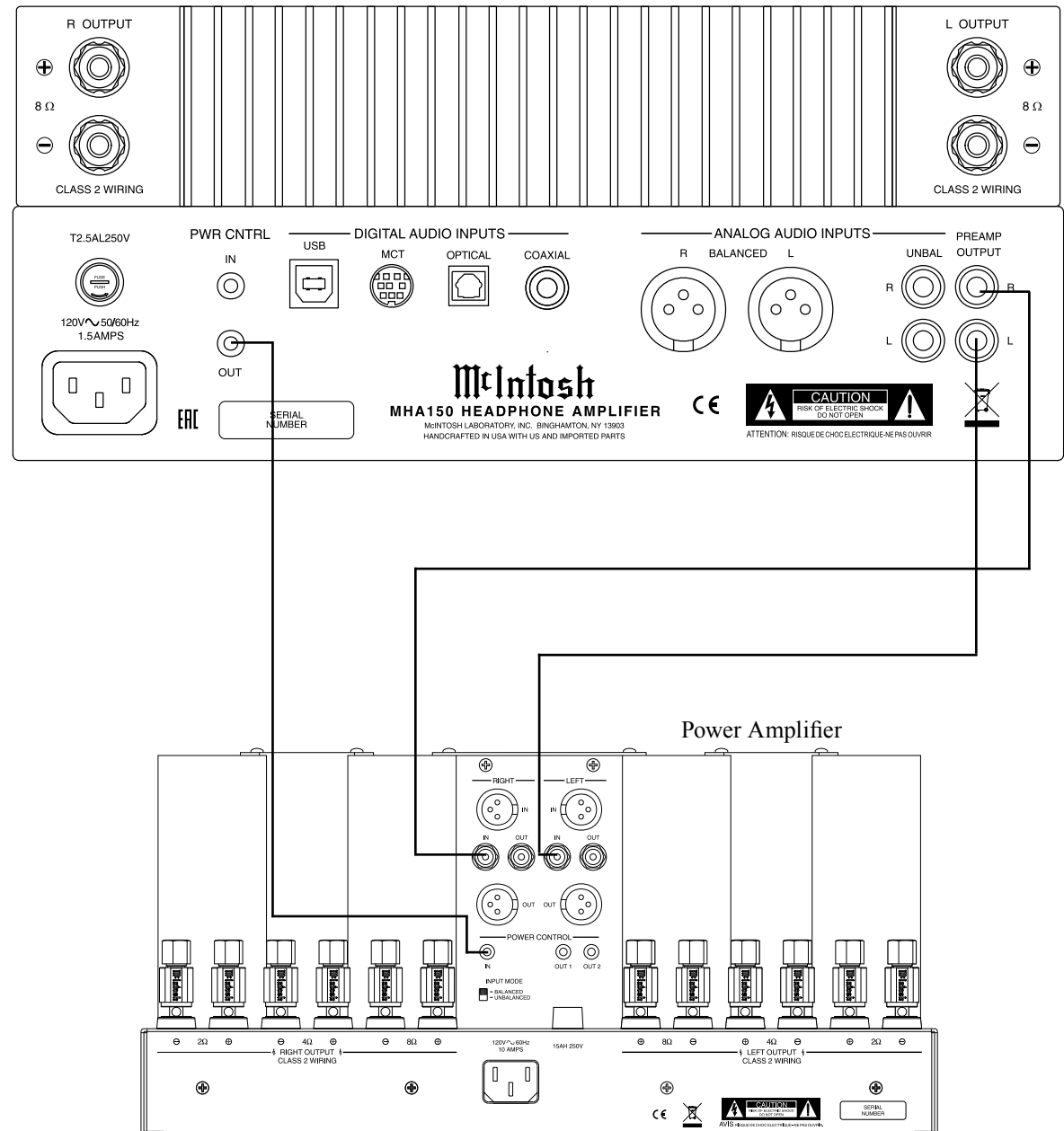

Adjusts or Selects the active TRIM function; also manually tune down the dial with contemporary McIntosh Tuners

Press to activate TRIM Mode

Scrolls through TRIM Functions

Decreases the volume level

Selects the desired INPUT

Mutes and unmutes the audio

Selects the PREVIOUS ⏮ Station Preset on contemporary McIntosh Tuners

Directional Push-buttons - Up, Down, Left and Right

Adjusts or Selects the active TRIM function; also manually tune up the dial with contemporary McIntosh Tuners

Scrolls through TRIM Functions

Increases the volume level

LED illuminates during the time a remote command is sent to the MHA150

Powers the MHA150 ON or OFF

Selects the NEXT ⏭ Station Preset on contemporary McIntosh Tuners

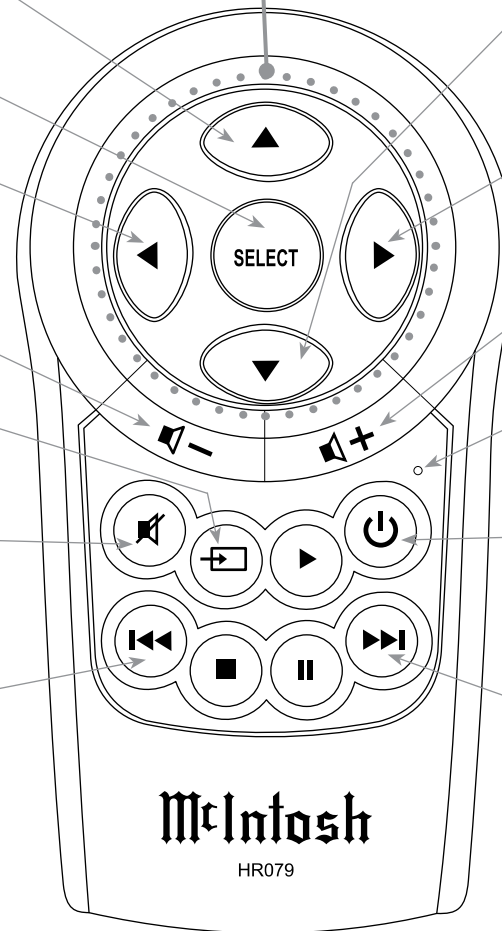

*Note: Push-buttons whose function is not identified above are for use with other McIntosh Products.*

## How to use the Remote Control



The supplied Remote Control performs the various Operating Functions for the MHA150 Headphone Amplifier.

*Note: Refer to the "How to Operate" Section of this manual for additional information.*

### Input Source Selection

Press the Push-button  to select the desired program source.

### Volume

Press the + or - Push-buttons to increase or decrease the listening level.





### Mute



Press the  (Mute) Push-button to mute the audio and a second time to resume listening.

### Select Push-Button



Press the Select Push-button to activate the TRIM Mode. Then use the Directional Push-Buttons to select a Trim Mode Function and make changes.

### Directional Push-Buttons

After having pressed the SELECT Push-button, press the   (Left or Right) Push-buttons to scroll through the various Trim Functions. Then press the   (Up or Down) Push-buttons to make a change to the current Trim Setting.

*Note: If a contemporary McIntosh Tuner is used with the MHA150 the   (Up or Down) on the Remote Control will allow for manual tuning of stations. Refer to "General Information, note 6" on page 4 for additional information.*

### Back and Next

When using an optional contemporary McIntosh Tuner with the MHA150, select the next Station Preset by pressing the  Push-button. Select the previous Station Preset by pressing the  Push-button.



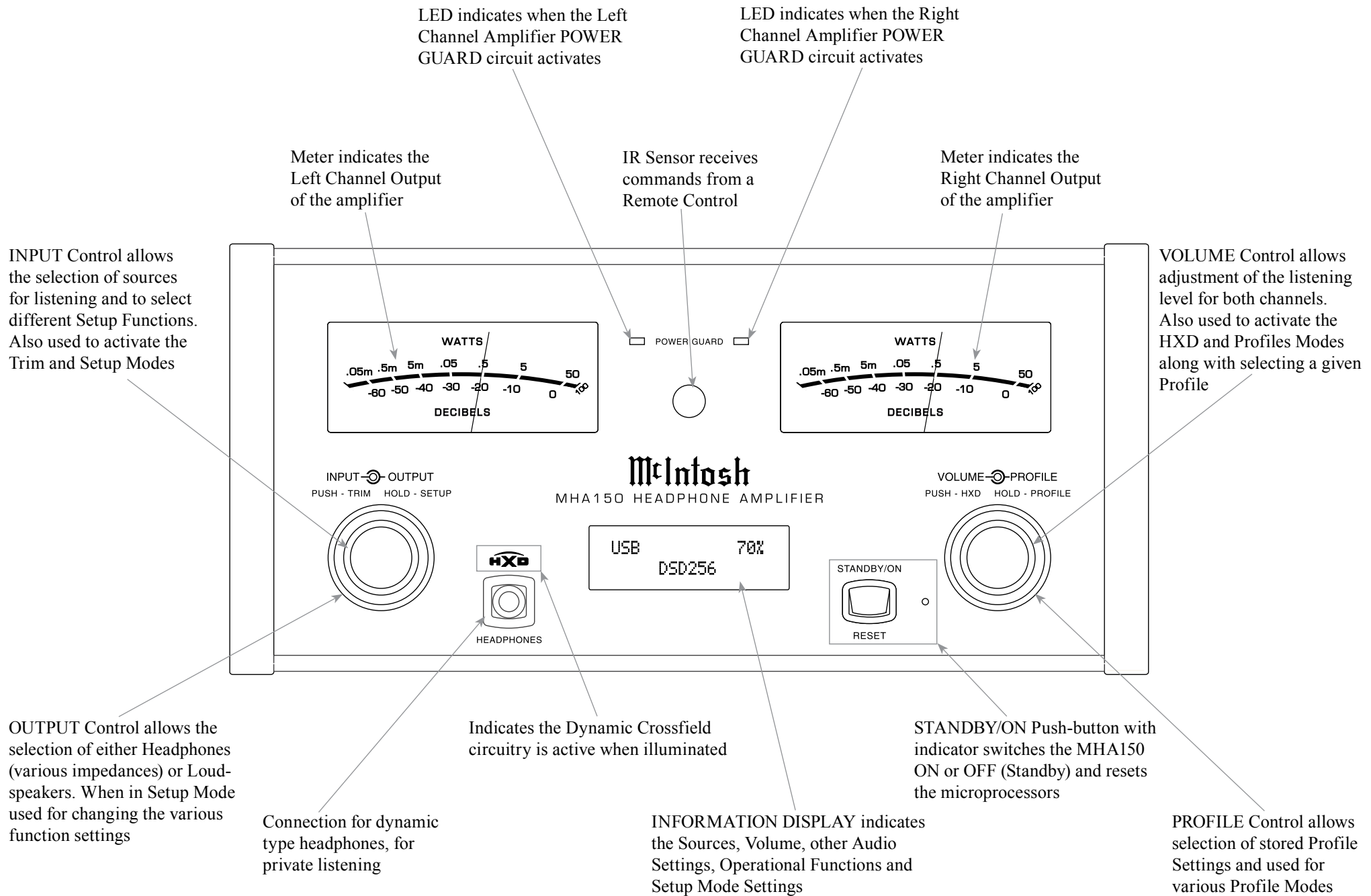



## How to Operate the Setup Mode

Your McIntosh MHA150 has been factory configured for default operating settings that will allow immediate enjoyment of superb audio without the need for further adjustments. If you wish to make changes to the factory default settings, a Setup Feature is provided to customize the operating settings using the Front Panel Display. Refer to the MHA150 Front Panel Illustration on the previous page while performing an introduction into operating the Setup Mode, follow the steps below.

*Note: If the MHA150 is currently On, proceed to step 2.*

1. Press the STANDBY/ON Push-button on the Front Panel or press the  (Power) Push-button on the Remote Control to switch On the MHA150. The MHA150 will go through a brief startup initialization with the Front Panel Display indicating the last used input and volume setting. This is followed by the volume setting indication starting at zero and then increasing to the last used volume setting. Refer to figure 1.



Figure 1

*Note: When listening with Loudspeakers, rotate the OUTPUT Control to the “Speakers” setting.*

2. Press and hold in the INPUT CONTROL until the Front Panel Display indicates “MHA150 V\_.\_, S/N: AET\_.”. The information indicated on the Front Panel Display includes the Model Number, Firmware Version and the Serial Number for this unit; see page 18 for additional information. Refer to figure 2.



Figure 2

3. Next, rotate the INPUT CONTROL Clockwise again until the Front Panel Display indicates “INPUT: UNBAL, NAME: UNBAL” Refer to figure 3.



Figure 3

4. Rotate the INPUT CONTROL Clockwise again to select other Setup Functions. Refer to pages 18 thru 20.
5. To exit from the Setup Mode, press the INPUT CONTROL and the Front Panel Display will revert back to its normal display. Refer to figure 1.

## Default Settings

The Default Settings Chart below indicates the Function Name, Default Setting and the Page Number for additional information.

Default Settings		
Function Name	Setting	Page No.
MHA150	V_.__ S/N: AET_.	18
INPUT NAME (Reassign Input Names)	INPUT: _____ NAME: _____	18
SPEAKER MODE	Large	19
SUBWOOFER MODE	Disabled	19
POWER MODE (Auto Off)	Enabled	20
REMOTE CONTROL	Enabled	20
VOLUME GUARD	Enabled	20
FACTORY RESET (Hold SETUP)	----	20

*Note: Setup Mode operations should be performed in the order they appear in the Setup Menu as they are interactive.*



## Firmware Version

The MHA150 functionality is controlled by internal software that is known as Firmware. The Version of the Firmware in the MHA150 can be identified at any time by utilizing the Setup Mode.

1. Press and hold the INPUT CONTROL until the Front Panel Display indicates “MHA150 V\_.\_., S/N: AET\_.\_.”. The number after the “V” is the firmware version and the number after the “S/N” is the serial number of the unit. Refer to figure 2.



Figure 2

2. To exit from the Setup Mode, press the INPUT CONTROL and the Front Panel Display will revert back to its normal display.

## Input Renaming

The MHA150 Default Input Names (UNBAL, BALANCED, OPTICAL, COAX and AES/EBU as indicated on the Front Panel Display) can be customized with a different name up to eight characters long (My Phone, MCD550, etc.). The available characters for renaming the input include the following: ! < > \* , / - \_ 0 1 2 3 4 5 6 7 8 9 a b c d e f g h i j k l m n o p q r s t u v w x y z A B C D E F G H I J K L M N O P Q R S T U V W X Y Z .

In the following example, the UNBAL Input will be renamed to “MY-PHONE”.

1. Press and hold the INPUT CONTROL until the Front Panel Display indicates the Model, Firmware Version and Serial Number. Refer to figure 2. Then rotate the INPUT CONTROL and select the Setup Menu item “INPUT: UNBAL, NAME: UNBAL”. Refer to figure 4.



Figure 4

*Note: If the UNBAL Input is not displayed, rotate the OUTPUT Control repeatedly until it is displayed.*

2. Press and hold in the INPUT Control until the character “U” of the “NAME: UNBAL” starts flashing (and is underlined). Refer to figure 5.



Figure 5

3. Rotate the INPUT Control until the character “M” appears. Refer to figure 6.
4. Rotate the OUTPUT Control until the character “N” of the “NAME: UNBAL” starts flashing. Refer to figure 7.



Figure 6



Figure 7

5. Rotate the INPUT Control until the character “Y” appears. Refer to figure 8.



Figure 8

6. Repeat steps 3 thru 5 until the new name of “MY-PHONE” is indicated on the Front Panel Display. Refer to figures 9 thru 11.



Figure 9



Figure 10



Figure 11

7. To save the new Input Name press and hold the INPUT Control until the “character underline” disappears on the Front Panel Display. Refer to figure 12.



Figure 12

Record any changes made to the various default Input Names in the following chart for future reference.

Input Renaming	
Default Input Name	New Input Name
UNBAL	
BALANCED	
OPTICAL	
COAXIAL	
MCT	
USB	

8. To exit from the Setup Mode, press the INPUT CONTROL and the Front Panel Display will revert back to its normal display.

### Speaker Mode

The MHA150 allows for the connection of Loudspeakers with different performance capabilities. One of the differences in Loudspeaker performance is the ability to reproduce bass frequencies down to 35Hz within -3dB of the midrange frequencies.

The MHA150 provides two different settings, LARGE and SMALL. The LARGE listing refers to the Loudspeaker's capability for reproducing bass frequencies down to 35Hz within -3dB of the midrange frequencies. If a Loudspeaker can not reproduce bass frequencies down to 35Hz within -3dB of the midrange frequencies, it is considered SMALL.

In the following example, the Speaker Size default setting of LARGE will be changed to SMALL:

1. Press and hold the INPUT CONTROL until the Front Panel Display indicates the Model, Firmware Version and Serial Number. Refer to figure 2. Then rotate the INPUT CONTROL and select the Setup Menu item "SPEAKER MODE, Large". Refer to figure 13.



Figure 13

2. Rotate the OUTPUT Control until the Front Panel Display indicates "SPEAKER MODE, Small". Refer to figure 14.



Figure 14

3. To exit from the Setup Mode, press the INPUT CONTROL and the Front Panel Display will revert back to its normal display.

### Subwoofer Mode

The MHA150 is designed to work with an external Powered Subwoofer. The subwoofer would be used when the Loudspeakers connected to MHA150 Output Terminals do not have the ability to reproduce bass frequencies down to 35Hz (within -3dB of the midrange frequencies).

The MHA150 provides two different Subwoofer Mode settings, "Disabled" and "Enabled". The Default Setting of "Disabled" provides a Stereo Signal at the PREAMPLIFIER OUTPUT Jacks. When the setting is changed to "Enabled" the Left and Right channel signals are combined into a monaural signal available at both PREAMP OUTPUT Jacks. In the following example, the Subwoofer Mode default setting of DISABLED will be changed to Enable:

1. Press and hold the INPUT CONTROL until the Front Panel Display indicates the Model, Firmware Version and Serial Number. Refer to figure 2. Then rotate the INPUT CONTROL and select the Setup Menu item "SUBWOOFER MODE, Disabled".

Refer to figure 15.



Figure 15

2. Rotate the OUTPUT Control until the Front Panel Display indicates "SUBWOOFER MODE, Enabled". Refer to figure 16.



Figure 16

*Note: When the MHA150 Subwoofer Mode is set to "ENABLED" it is important the Powered Subwoofer internal crossover frequency be set to 80Hz. It is recommended the Professionals at your McIntosh Dealer, who are skilled in all aspects of room acoustics be involved when the MHA150 is used with a Powered Subwoofer and any associated audio equipment.*

3. To exit from the Setup Mode, press the INPUT CONTROL and the Front Panel Display will revert back to its normal display.

### Power Mode

The MHA150 incorporates an Auto Off Feature, which automatically places it into the Power Saving Standby/Off Mode. This occurs approximately 30 minutes after there has been an absence of audible audio signals on the selected input (on either channel) or user activity (includes changes to any of the Operation Functions such as source selection, volume adjustment, etc). If it is desirable to disable the Auto Off Feature perform the following steps:

1. Press and hold the INPUT CONTROL until the Front Panel Display indicates the Setup Mode is

## Power Mode, con't

active. Then rotate the INPUT CONTROL until the Setup Menu item “POWER MODE, Enabled” appears on the Front Panel Display. Refer to figure 17.



Figure 17

2. Rotate the OUTPUT Control until “POWER MODE, Disabled” appears on the Front Panel Display. Refer to figure 18.



Figure 18

3. To exit from the Setup Mode, press the INPUT CONTROL and the Front Panel Display will revert back to its normal display.

## Remote Control

The Front Panel IR Sensor used for Remote Control Operation can be disabled in the event there is a conflict with another McIntosh component located in the same room as the MHA150. Refer to “General Information, note 6” on page 4 for additional information. Disable the Front Panel IR Sensor by performing the following steps:

1. Press and hold the INPUT CONTROL until the Front Panel Display indicates the Model, Firmware Version and Serial Number. Then rotate the INPUT CONTROL and select the Setup Menu item “REMOTE CONTROL, Enabled”. Refer to figure 19.



Figure 19

2. Rotate the OUTPUT Control until the Front Panel Display indicates “REMOTE CONTROL, Disabled”. Refer to figure 20.



Figure 20

3. To exit from the Setup Mode, press the INPUT CONTROL and the Front Panel Display will revert back to its normal display.

## Volume Guard

The MHA150 incorporates a Volume Guard Feature to provide Loudspeaker Protection if the Amplifier was set to a high listening level the last time it was used. When it is switched back ON, the volume listening will return to a normal safe level. If desirable, the Volume Guard Feature may be switched OFF by performing the following steps:

1. Press and hold the INPUT CONTROL until the Front Panel Display indicates the Setup Mode is active. Then rotate the INPUT CONTROL until the Setup Menu item “VOLUME GUARD, Enabled” appears on the Front Panel Display. Refer to figure 21.



Figure 21

2. Rotate the OUTPUT Control until “VOLUME GUARD, Disabled” appears on the Front Panel Display. Refer to figure 22.



Figure 22

3. To exit from the Setup Mode, press the INPUT CONTROL and the Front Panel Display will revert back to its normal display.

## Factory Reset

If it becomes desirable to reset all the adjustable settings (Setup and Trim Settings) to the factory default values, perform the following steps:

1. Press and hold in the INPUT Control to enter the SETUP MODE. Refer to figure 2 on page 18.
2. Rotate the INPUT Control until “FACTORY RESET, (Hold SETUP)” appears on the Information Display. Refer to figure 23.



Figure 23

3. Press and hold in the INPUT Control until “FACTORY RESET, In Progress!” appears on the Information Display, then release the INPUT Control. Refer to figures 24 and 25.



Figure 24



Figure 25

4. Press the Front Panel STAND/BY Push-button to switch the MHA150 On.

## How to Operate the MHA150

### Power On and Off

The Red LED beside the STANDBY/ON Push-button lights to indicate the MHA150 is in Standby mode. To switch ON the MHA150, press the STANDBY/ON Push-button on the Front Panel or press the  (Power) Push-button on the Remote Control. The MHA150 will go through a brief startup initialization, with the Front Panel Display indicating the last used input and volume setting. This is followed by the volume setting indication starting at zero and then increasing to the last used volume setting. Refer to figures 50, 51 and 52. To switch OFF the MHA150, press the STANDBY/ON Push-button on the Front Panel or the OFF Push-button on the Remote Control.



Figure 51

*Note: For an explanation of the Remote Control Push-button functions, refer to pages 14 and 15.*

### Source Selection

Rotate the INPUT Control to select the desired input

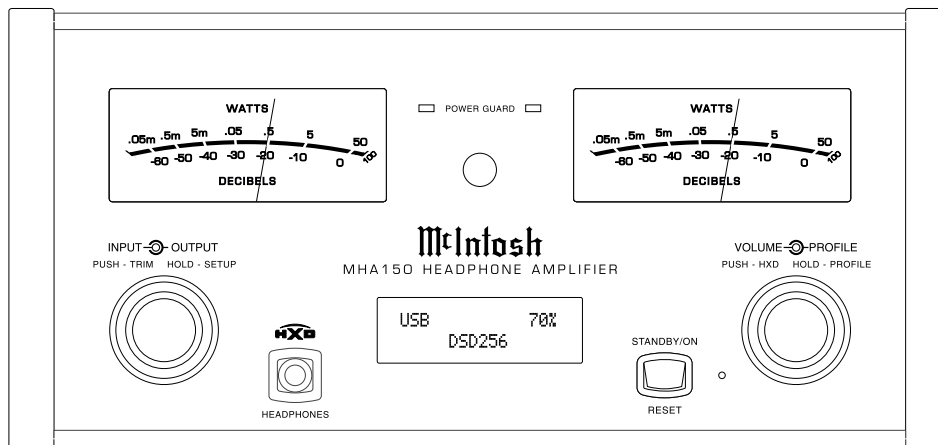



Figure 50

or press the appropriate push-button on the Remote Control. Refer to figures 50 and 52.

### Volume Control

Rotate the Front Panel VOLUME Control or use the Up  (+) or Down  (-) Push-buttons on the Remote Control for the desired listening level. Refer to figures 50 and 52.

### Trim Functions Introduction

The MHA150 has various Trim Selections with Adjustments. The Trim Functions include Bass Boost, Balance, Level (Input Trim), Mono/Stereo, Meter Backlight, Display (Information) and Digital Audio (Display Information). The Bass Boost, Balance, Level (Input Trim), Mono/Stereo, Trim Settings are stored in memory independently for each Input Selected; the other Trim Settings are the same for all inputs.

The selection and adjustment of all Trim Functions may be performed by first momentarily pressing the Front Panel INPUT Control. Then rotate the INPUT Control to select the desired Trim Function. This is followed by rotating the OUTPUT Control to make a

change/adjustment in the Trim Setting. To verify a TRIM Setting without changing it, press the INPUT Control and then Rotate the INPUT Control to select the desired Trim Function. After approximately 5 seconds the Display returns to indicate the Input Selection and Volume Level.

### BASS BOOST

The Intensity of the Low Frequencies in the music can be increased by using the Bass Boost Trim Function. To make an adjustment perform the following:

1. Momentarily press the Front Panel INPUT Control to enter the TRIM Mode. Then rotate the INPUT Control until “BASS BOOST, 0dB” appears on the Front Panel Display. Refer to figure 53.



Figure 53

2. Rotate the OUTPUT Control to change the Bass Boost, the range of adjustment is from 0dB to +12.5 dB in 2.5 dB steps. Refer to figure 54.

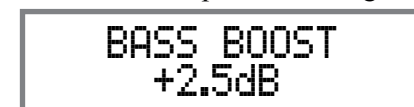

Figure 54

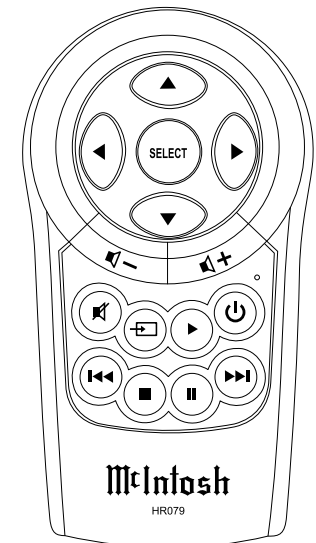

Figure 52

## How to Operate the MHA150, con't

After approximately 5 seconds the Display returns to indicate the Input Selection and Volume Level.

### BALANCE

The Channel Balance while listening can vary with different program sources. When using Loudspeakers, the room acoustics and listening positions also can effect the Channel Balance. Use the Balance Trim Function as needed to achieve approximately equal listening volume levels in each channel. To adjust the Balance perform the following:

1. Momentarily press the Front Panel INPUT Control to enter the TRIM Mode. Then rotate the INPUT Control until "L BALANCE R" appears on the Front Panel Display. Refer to figure 55.



Figure 55

2. Rotate the OUTPUT Control to change the Channel Balance, the range of adjustment is 50dB (to emphasize the Left or Right Channel) in 1 dB steps. Refer to figures 56 and 57.



Figure 56



Figure 57

After approximately 5 seconds the Display returns to indicate the Input Selection and Volume Level.

### TRIM LEVEL

Source Components can have slightly different volume levels resulting in the need to readjust the MHA150 Volume Control when switching between different Inputs. The MHA150 allows the adjustment of levels for each of the Inputs for the desired same relative volume. The UNBAL and OPTICAL Inputs are used in the following example.

*Note: The TRIM Level Adjustments made are retained in permanent memory.*

1. Rotate the INPUT Control to select the UNBAL Input and adjust the VOLUME Control for the desired listening level.
2. Momentarily press the Front Panel INPUT Control to enter the TRIM Mode. Then rotate the INPUT Control until "TRIM LEVEL, \_.\_ dB" appears on the Front Panel Display. Rotate the OUTPUT Control until the Front Panel Display indicates "TRIM LEVEL, 0.0dB". Refer to figure 58.



Figure 58

The range of TRIM Adjustment is  $\pm 6$ dB. Refer to figures 59 and 60.



Figure 59

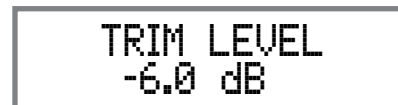

Figure 60

*Note: The UNBAL Input is serving as a reference level or choose another Input frequently listened to.*

3. Note the current listening level. Then rotate INPUT Control to select the OPTICAL Input and note if the relative volume is louder or quieter than the volume level of the UNBAL.
4. Momentarily press the Front Panel INPUT Control to enter the TRIM Mode. Then rotate the INPUT Control until "TRIM LEVEL, \_.\_ dB" appears on the Front Panel Display. Using the OUTPUT Control adjust the TRIM Level to match the same relative volume level heard when listening to the UNBAL Input.
5. In our example, the relative volume level of the OPTICAL Input is louder than the UNBAL Input, so the trim level for the OPTICAL Input is reduced to -2.5 dB. Refer to figure 61.



Figure 61

6. Repeat steps 1 thru 4 until the relative volume is the same between the UNBAL and OPTICAL Inputs.
7. Repeat the above steps for the remaining inputs with component sources connected until they all have the same relative volume levels. Record any changes made to the various inputs from the default settings in the "Input Trim Settings" Chart on the next page.

After approximately 5 seconds the Display returns to indicate the Input Selection and Volume Level.

### MONO/STEREO MODE

By default the Stereo Mode is active for all Input Sources however, any Input Source may be assigned to Mono Mode. To change Stereo Mode to Mono for a given Input Source, perform the following steps:

1. Momentarily press the Front Panel INPUT Control to enter the TRIM Mode. Then rotate the INPUT Control until “MONO / STEREO” appears on the Front Panel Display. Refer to figure 62.



Figure 62

2. Rotate the OUTPUT Control to change the Mode to “Mono”. Refer to figure 63.



Figure 63

After approximately 5 seconds the Display returns to indicate the Input Selection and Volume Level.

Input Trim Settings		
Connection Type	Input Name	New Trim Level
UNBAL		
BALANCED		
OPTICAL		
COAXIAL		
MCT		
USB		

### METER LIGHTS

The MHA150 Front Panel Meter Illumination may be switched On or Off by performing the following:

1. Momentarily press the Front Panel INPUT Control to enter the TRIM Mode. Then rotate the INPUT Control until “METER LIGHTS, On” appears on the Front Panel Display. Refer to figure 64.
2. Rotate the OUTPUT Control to change illumination to “Off”. Refer to figure 65.



Figure 64



Figure 65

After approximately 5 seconds the Display returns to indicate the Input Selection and Volume Level.

*Note: Meter Illumination of contemporary McIntosh Power Amplifiers will also switch On/Off when connected to the MHA150 via a power control cable. Refer to “Power Control Connections” on page 4.*

### DISPLAY

The MHA150 Front Panel Display Illumination may be switched On or Off by performing the following:

1. Momentarily press the Front Panel INPUT Control to enter the TRIM Mode. Then rotate the INPUT Control until “DISPLAY, Always On” appears on the Front Panel Display. Refer to figure 66.



Figure 66

2. Rotate the OUTPUT Control to change the Display to “DISPLAY, Auto Off”. Refer to figure 67.



Figure 67

After approximately 5 seconds the Display will switch Off. When a Front Panel Control Operation or Remote Control Operation occurs, the Front Panel Display will

switch On to indicate current status. Then approximately 5 seconds later the Display will switch Off.

### DISPLAY INFORMATION MODE

By default, the Display INFO Mode is set to indicate the Sample Rate for Digital Input Sources. The other Display INFO Mode will indicate the amplifier Output Mode (Headphones with an impedance range or Speakers) information. To change from the default setting perform the following steps:

1. Momentarily press the Front Panel INPUT Control to enter the TRIM Mode. Then rotate the INPUT Control until “DISPLAY INFO, Sample Rate” appears on the Front Panel Display. Refer to figure 68.



Figure 68

2. Rotate the OUTPUT Control to change the Display Mode to “DISPLAY INFO, Output”. Refer to figure 69.



Figure 69

After approximately 5 seconds, the Display returns to indicate the Input Selection and Volume Level.

### Mute

Press the MUTE Push-button on the Remote Control to Mute the Audio in the Headphones, Loudspeakers and PRE AMP OUTPUT Jacks. The Front Panel Display will indicate the Input Name with the word MUTE in place of the actual volume setting. Refer to figure 70 on the next page.



## How to Operate the MHA150, con't

UNBAL MUTE

Figure 70

To un-MUTE the Audio, press the MUTE Push-button on the Remote Control, adjust the Volume level or change Inputs.

### Headphones Jack

Connect a pair of dynamic headphones to the Headphones Jack with a 1/4" (6.3mm) stereo phone type plug for private listening.

*Note: Use the OUTPUT Control to select the correct impedance range.*

### Headphone HXD®

The MHA150 Headphone Crossfeed Director (HXD®) improves the sound localization for Headphone Listening. HXD® restores the directionality component of the spatial sound stage normally heard with Loudspeaker listening. To activate the HXD® when Headphones are connected to the Front Panel Headphone Jack perform the following:

1. Momentarily press the Front Panel VOLUME Control to enable the HXD® Mode. The HXD® Icon located above the Headphone Jack will illuminate Green. Refer to figure 71.
2. To disable the HXD® Mode momentarily press the Front Panel VOLUME Control.



*Note: HXD® Mode is automatically disabled when SPEAKERS are selected with the OUTPUT Control.*

HXD® is a registered trademark of McIntosh Laboratory, Inc.

### Output Control

Rotate the OUTPUT Control to select the desired listening device, Headphones or Loudspeakers. Refer to the OUTPUT CONTROL SELECTION chart below:

- Notes:*
1. For the best performance and safety, it is important to always match the impedance of the Headphones and Loudspeakers to the MHA150 Output.
  2. Do not exceed the maximum power handling capacity of Headphones or Loudspeakers connected to the MHA150.
  3. The first time the OUTPUT Control is rotated, the Front Panel Display will indicate the current Output selection.

### Profile Control

Rotate the PROFILE Control to select from up to 5 different Profile Settings for Headphone use. The default Profile Setting is for the McIntosh MHP1000

Headphones. Refer to figure 72.

UNBAL MHP1000 20%

Figure 72

### Profile Mode

Each profile setting stores the selected Headphone Impedance Range, HXD Setting (On or Off), Bass Boost Setting (0 to +12.5 dB) and assigns a custom name to it. In the following example a second Profile will be created, recalled, renamed and finally deleted using the Profile Setup Mode:

#### PROFILE SETTINGS

1. Using the OUTPUT Control select, from the six choices available, the correct impedance and power output for the Headphones that will be used for listening. Refer to the chart below.

OUTPUT CONTROL SELECTION				
Listening Device	Impedance in Ohms (Ω)	Power Level	Output	Front Panel Display
Speakers	8 Ω	---	50 Watts	UNBAL SPEAKERS 21%
Headphones	8 to 40 Ω	Norm	250 milliwatts	UNBAL NORM 8Ω - 40Ω 21%
Headphones	40 to 150 Ω	Norm	250 milliwatts	UNBAL NORM 40Ω - 150Ω 21%
Headphones	150 to 600 Ω	Norm	250 milliwatts	UNBAL NORM 150Ω - 600Ω 21%
Headphones	8 to 40 Ω	High	1 Watt	UNBAL HIGH 8Ω - 40Ω 21%
Headphones	40 to 150 Ω	High	1 Watt	UNBAL HIGH 40Ω - 150Ω 21%
Headphones	150 to 600 Ω	High	1 Watt	UNBAL HIGH 150Ω - 600Ω 21%



2. If desired, select the HXD™ Mode by momentarily pressing the VOLUME Control. The HXD Icon located above the Headphone Jack will illuminate Green. Refer to figure 71.

3. If desired, select the amount of TRIM Bass Boost by momentarily pressing the INPUT Control. Then rotate the INPUT Control to select BASS BOOST followed by using the OUTPUT Control for the desired increase. Refer to figures 53 and 54 on page 21.

**CREATE A PROFILE**

With the Impedance/Power, HXD and Bass Boost settings made, they will now be assigned to a Profile, for easy recall at a later time. The PROFILE and VOLUME Controls are used to perform the various Profile Functions (Save, Select Rename and Delete). When the PROFILE Control is rotated and there are no saved Profiles, the Front Panel Display will indicate the currently selected Input and “UNBAL 20%, No Profile”. Refer to figure 79.



Figure 79

Create a new Profile by following the below steps:

4. Press and hold in the VOLUME CONTROL until the Front Panel Display indicates “SAVE PROFILE, MHP1000”. Refer to figure 80.



Figure 80

5. Rotate the PROFILE Control until the Front Panel Display indicates “SAVE PROFILE, Profile2”. Refer to figure 81.



Figure 81

6. To save Profile2 press and hold in the VOLUME Control until the Front Panel Display indicates “SAVE PROFILE, Profile Saved”. Refer to figure 82.



Figure 82

7. To exit the Profile Setup Mode momentarily press the VOLUME Control and the Front Panel Display returns to indicating the selected Input and Volume Setting.

**RENAMING A PROFILE**

The MHA150 Profile Name (MHP1000[Profile1] thru Profile5) can be customized with a different name up to eight characters long (Y10-PRO, etc.). The available characters for renaming the input include the following: ! < > \* , / - \_ 0 1 2 3 4 5 6 7 8 9 a b c d e f g h i j k l m n o p q r s t u v w x y z A B C D E F G H I J K L M N O P Q R S T U V W X Y Z . In this example the previously created and saved Profile2 will be renamed to “Y10-PRO” by performing the following steps:

8. Referring to figure 83, rotate the PROFILE Control to select “UNBAL 20%, Profile2”.



Figure 83

9. Select the “Profile Mode” by pressing and holding in the VOLUME Control and rotating the VOLUME Control until the Front Panel Display indicates “NAME PROFILE, Profile2”.

Refer to figure 84.



Figure 84

10. Press and hold the VOLUME Control until the character “P” of the “Profile2” starts flashing (and is underlined). Refer to figure 85.



Figure 85

11. Rotate the VOLUME Control until the character “Y” appears. Then Rotate the PROFILE Control until the character “r” of the “Yrofile1” starts flashing. Refer to figure 86.



Figure 86

12. Rotate the VOLUME Control until the character “1” appears. Then rotate the PROFILE Control until the character “o” of the “Y1ofile1” starts flashing. Refer to figure 87.



Figure 87

13. Repeat steps 10 thru 12 until the new Profile Name of “Y10-PRO” is indicated on the Front Panel Display. Refer to figure 88.

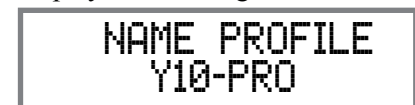

Figure 88



## How to Operate the MHA150, con't

### Profile Mode, con't

14. To store the renamed Profile into memory press and hold in the VOLUME CONTROL until the Front Panel Display indicates “SAVE PROFILE, Profile Saved”. Refer to figure 89.



Figure 89

15. To exit the Profile Rename Mode momentarily press the VOLUME Control.

### DELETING PROFILES

There are two ways to Delete Profiles, delete one saved Profile or delete all saved Profile Names. In the first example, one Profile will be deleted. Perform the following steps:

16. Using the PROFILE Control, select the Profile to be deleted. Refer to figure 90.



Figure 90

17. Rotate the VOLUME Control to select “DELETE PROFILE, MHP1000”. Refer to figure 91.



Figure 91

18. Press and hold in the VOLUME Control until the Front Panel Display indicates “DELETE PROFILE, Profile Deleted”. Refer to figure 92.



Figure 92

19. To exit the Profile Delete Mode momentarily press the VOLUME Control.

To Delete All the stored Profiles, perform the following steps:

20. Using the PROFILE Control, select one of the available Profiles. Refer to figure 93.



Figure 93

21. Rotate the VOLUME Control to select “DELETE ALL, Saved Profiles”. Refer to figure 94.



Figure 94

22. Press and hold in the VOLUME CONTROL until the Front Panel Display indicates “DELETE ALL, All Deleted”. Refer to figure 95.



Figure 95

23. To exit the Profile Delete Mode momentarily press the VOLUME Control.

### Power Output Meters

The MHA150 Power Output Meters indicate the power delivered to the Headphones or Loudspeakers. Refer to figure 100. The meters respond to all the

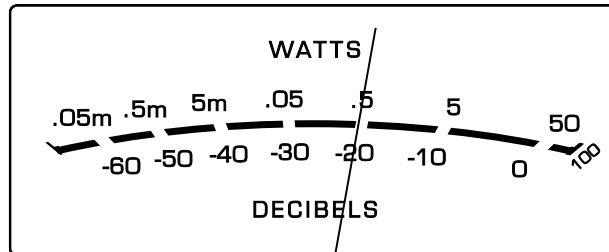

Figure 100

musical information being produced by the Amplifier. They indicate to an accuracy of at least 95% of the power output with only a single cycle of a 2,000Hz tone burst.

### Power Guard

During normal operation, the Front Panel Power Guard Indicators will momentarily illuminate during peaks in the audio signals. In the event the MHA150 over heats, due to improper ventilation, high ambient temperature and/or impedance mismatch, the internal protection circuits will activate. The Front Panel Power Guard Indicators will continuously illuminate and the audio will be muted. When the MHA150 has returned to a safe operating temperature, normal operation will resume.

### Using a Separate Power Amplifier or Subwoofer

To use a separate Amplifier instead of the MHA150 built-in Power Amplifier, connect the Loudspeakers to the separate Power Amplifier. Refer to page 13 “External Power Amplifier Connections” for additional connection information. An external Powered Subwoofer may also be used with the MHA150. Refer to page 19 “Subwoofer Mode” for additional information.

When either an External Power Amplifier or Powered Subwoofer is used with the MHA150 the Rear Panel PREAMP OUTPUT Jacks are used. Refer to figure 101.

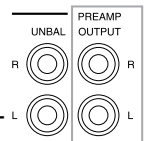

Figure 101

### System Thru Operation

When the MHA150 is connected to a Main Preamplifier or Audio/Video Controller (as illustrated on page 12) it is important to maximize the combined

performance. For the best performance, the volume control on the MHA150 should be set to 70%. The Volume Control on the Main Preamplifier or Audio/Video Controller should be used to adjust the listening volume level.

**Digital Inputs**

When a Digital Input (Optical, Coaxial, MCT or USB Connection) on the MHA150 is selected, the Front Panel Display will indicate the Sampling Frequency when a signal is present “48kHz”. Refer to figure 102. During the time there is no Digital Signal present the display will indicate “SILENT”. Refer to figure 103.



Figure 102



Figure 103

**USB Input Operation and Driver Installation**

The MHA150 USB Input provides the capability to playback music from a computer, when the computer is connected to the rear panel USB connector.

*Note: The USB Input is for direct connection to a computer only. To playback music from an USB Drive, connect the USB Drive to another USB Port on the computer and select the USB Drive with the Media Playback Program.*

The MHA150 USB Input is compatible with PC Computers using Microsoft®, Windows 7 (SP1), Windows 8.1 and Windows 10. It is also compatible with Apple® Macintosh® Computers using OS-10.6.8 or later.

When using a PC Computer with Windows, a spe-

cial McIntosh USB Audio Software Driver needs to be installed on the PC Computer. The driver needs to be installed before connecting the MHA150 USB Input to the USB Port on the computer.

*Note: If an Apple Macintosh computer is used with the MHA150, no additional driver is required.*

The McIntosh USB Audio Windows Driver is available for download from the McIntosh Web Site: <http://www.mcintoshlabs.com/us/Support/Pages/Manuals.aspx>

Under “PRODUCT CATEGORY” select “Integrated Amplifiers” then under “MODEL NUMBER” select “MHA150”. Click on “SEARCH” then select “McIntosh-HD USB Audio Windows Drive D v2.0” and download the PC Windows Driver. Follow the instructions below to install the McIntosh MHA150 Driver:

**Purpose:** To Install the McIntosh USB Audio Windows Driver for use with McIntosh Products with an USB-Digital Audio Input.

- Requirements:**
1. A PC Computer with a functioning USB Port.
  2. Windows 7 (SP1 or greater), Windows 8 (8.1) or Windows 10 Operating System.
  3. An USB Cable with Type A to Type B Connectors.

**Installing the Software**

It is important to first install the downloaded software on your computer before connecting the McIntosh Product to the computer. The USB Driver is included in the downloaded software package.

*Note: Before installing this software, please check to see if the McIntosh Product(s) with the USB-Digital*

*Audio Input has the latest firmware version, if not update the firmware first.*

1. Unzip the downloaded McIntosh Windows USB Driver Software Package.
2. Run “McIntoshHDSwPkg\_20150814\_v1p9p110p2.zip”. Refer to figures 104 thru 111.
3. When the Windows Security window appears check the *Always trust software from “Savitech Corp.”* box and then the Install button. When the software has been installed, it is necessary to reboot the computer. Refer to figure 109.

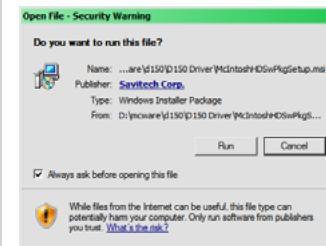

Figure 104



Figure 105

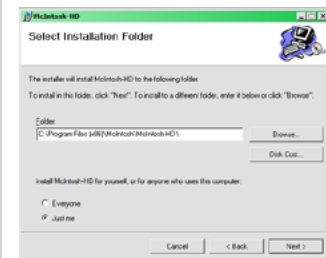

Figure 106

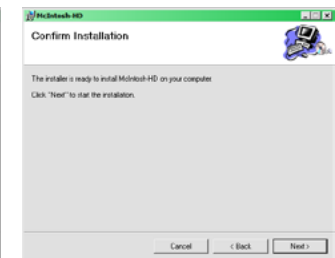

Figure 107

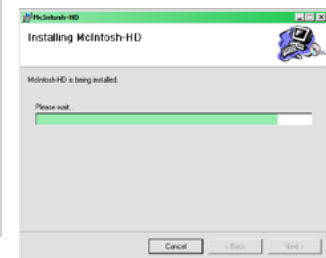

Figure 108

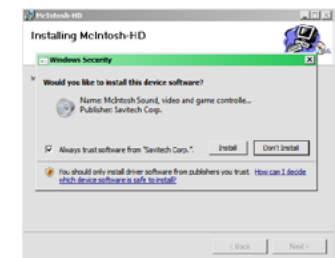

Figure 109

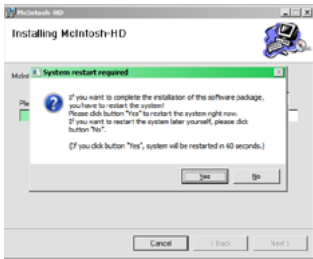

Figure 110

After rebooting, a McIntosh-HD icon will appear on the desktop. Refer to figure 112.

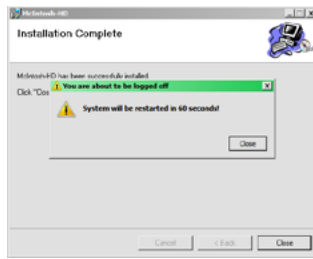

Figure 111



Figure 112

### USB Connection

Connect the USB Cable with Type A to Type B connectors between the PC Computer and the McIntosh Product with the USB-Digital Audio Input. An Icon will appear On-Screen indicating Windows has found new hardware. Refer to figure 113.

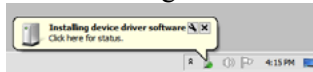

Figure 113

Upon completion of installing the driver, figure 114 will appear.

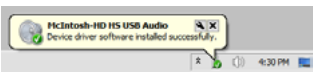

Figure 114

### Windows Sound Settings

For proper operation of the McIntosh Product via the Computer USB Connection, it is required to make changes to Windows Sound Settings:

1. From the Windows START button, click on “CONTROL PANEL” followed by selecting “SOUND”. Refer to figure 115.
2. Referring to figure 116, first select “McIntosh-HD HS USB Audio” and then

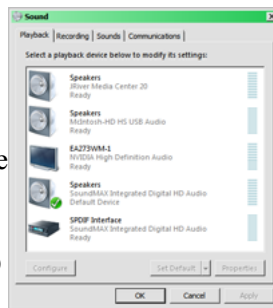

Figure 115

click on the “Set Default” button.

*Notes: 1. When the McIntosh USB Audio Product is not connected to your computer, the previous default Audio Device will be selected.*

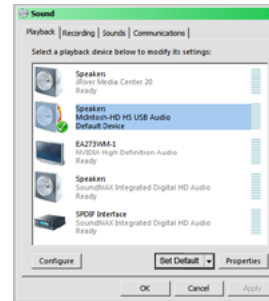

Figure 116

2. If other McIntosh Products with USB Audio Connections are also connected to the computer, an additional “McIntosh USB Audio” playback device will appear in the listing. Make sure to select the “McIntosh-HD HS USB Audio” from available playback devices listed when using this McIntosh Product for USB Audio.

### Control Panel Settings

To activate the McIntosh-HD USB Audio Control Panel, click on the “McIntosh Icon” (located in the Windows notification area on the right side of the taskbar) or click on the Windows “Show hidden icons”, then select the “McIntosh Icon”. Refer to figures 117 and 118.

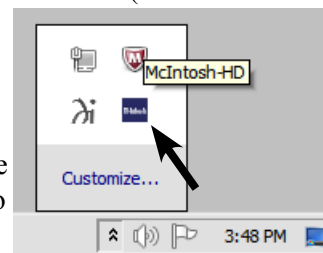

Figure 117

*Notes: 1. It is not necessary for the McIntosh-HD USB Audio Control Panel to be running, unless it is desired to make changes to the default settings.*

2. The McIntosh-HD USB Audio Control Panel displays the current Sampling Rate, Bit-Rate and Buffer Size for the music streaming from the computer into the MHA150.



Figure 118

3. When the Media Stream Program on the computer is set to output in the "ASIO" format, the McIntosh -HD USB Audio Control Panel allows for changing the settings parameters on the fly.

**USB Music Playback**

When the USB Input is selected on the McIntosh MHA150, the Front Panel Display indicates the Sampling Rate (refer to figures 119 and 120 for PCM Signals).



Figure 119



Figure 120

Figures 121 and 122 indicate a Sampling Rate of 128 or 256 times the Sampling Rate of a CD Disc for the incoming DSD Digital Audio Signal.



Figure 121



Figure 122

The Sampling Rate and the Bit Rate are determined by the original recording, the Application Output Format (when available) and the McIntosh-HD Control Panel Settings.

*Note: In general, when the original music is recorded at a higher Sampling Rate, the result is usually more detail in the music. However, this higher*

*rate results in consuming larger amounts of storage space. The Sample Rate usually should be set to match the Sample Rate of the music recording being played back.*

There are many third party Applications (besides Applications like Windows Media Player) for streaming music from the computer to the McIntosh MHA150 USB Input. An example of just one of the available applications is "JRiver Media Center".

**Reset of Microprocessors**

In the unlikely event the controls of the MHA150 stop functioning, the microprocessors can be reset by performing the following:

1. Press and hold in the STANDBY/ON Push-button until the LED above the STANDBY/ON Push-button illumination is extinguished. Then release the STANDBY/ON Push-button.
2. To switch the MHA150 back On, press the STANDBY/ON Push-button.

*Note: This can be performed with the MHA150 On or in the Standby Mode.*





## Amplifier Specifications

### Loudspeaker Power Output

50 watts is the minimum sine wave continuous average power output per channel, both channels operating

### Headphone Power Output

1 watt - High Selection  
250mWatts - Norm Selection

### Loudspeaker Output Load Impedance

8 ohms

### Headphone Output Load Impedance

8 - 40 ohms  
40 - 150 ohms  
150 - 600 ohms

### Rated Power Band

20Hz to 20,000Hz

### Total Harmonic Distortion

0.005% maximum with both channels operating from 250 milliwatts to rated power, 20Hz to 20,000Hz

### Dynamic Headroom (Loudspeaker)

1.5dB

### Frequency Response

+0, -0.5dB from 20Hz to 20,000Hz  
+0, -3dB from 10Hz to 100,000Hz

### Tone Control

Bass Boost 0 to +12.5dB (2.5dB steps) @ 40Hz

### Preamplifier Output (for rated input)

3V (8V Maximun)

### Signal To Noise Ratio (A-Weighted)

High Level, 105dB below rated output

### Sensitivity (for rated output)

300mV unbalanced  
600mV balanced

### Intermodulation Distortion

0.005% maximum, if the instantaneous peak power is 100 watts or less per channel with both channels operating for any combination of frequencies from 20Hz to 20,000Hz

### Wide Band Damping Factor

Greater than 150

### Input Impedance

25K ohms unbalanced  
25K ohms balanced

### Maximum Input Signal

8V unbalanced  
16V balanced

### Preamplifier Output Impedance

500 ohms

### Power Guard

Less than 2% THD with up to 16dB overdrive at 1,000Hz

### Voltage Gain

36.5dB

### Digital Input Sample Rates

Optical: PCM - 16Bit, 24Bit - 32kHz to 192kHz  
Coaxial: PCM -16Bit, 24Bit - 32kHz to 192kHz  
MCT: PCM, SACD, -16Bit, 24Bit - 32kHz to 192kHz  
USB: PCM - 16Bit, 24Bit, 32Bit - 32kHz to 384kHz  
DXD - DXD352.8kHz, DXD384kHz  
DSD - DSD64, DSD128, DSD256

### Power Control Input

5-15VDC, < 1mA

### Power Control Output

12VDC, 25mA maximum

## General Specifications

### Power Requirements

*Field AC Voltage conversion of the MHA150 is not possible. The MHA150 is factory configured for one of the following AC Voltages:*

100 Volts, 50/60Hz at 1.8 amps  
110 Volts, 50/60Hz at 1.5 amps  
120 Volts, 50/60Hz at 1.5 amps  
220 Volts, 50/60Hz at 0.9 amps  
230 Volts, 50/60Hz at 0.8 amps  
240 Volts, 50/60Hz at 0.8 amps  
Standby: Less than 0.25 watt

*Note: Refer to the rear panel of the MHA150 for the correct voltage.*

### Overall Dimensions

Width is 11-1/2 inches (29.2cm)  
Height is 5-7/8 inches (14.9cm) including feet  
Depth is 18 inches (45.7cm) including the Front Panel, Knobs and Cables

### Weight

26.5 pounds (12 kg) net, 32.5 pounds (14.8 kg) in shipping carton

### Shipping Carton Dimensions

Width is 19-3/8 inches (49.2cm)  
Depth is 16-1/4 inches (41.3cm)  
Height is 14-3/4 inches (37.5cm)

**Packing Instructions**

In the event it is necessary to repack the equipment for shipment, the equipment must be packed exactly as shown below. It is very important that the four plastic feet are attached to the bottom of the equipment. Failure to do this will result in shipping damage.

Use the original shipping carton and interior parts only if they are all in good serviceable condition. If a shipping carton or any of the interior part(s) are needed, please call or write Customer Service Department of McIntosh Laboratory. Refer to page 3. Please see the Part List for the correct part numbers.

**MHA150 Packing Material List**

Quantity	Part Number	Description
1	034548	Shipping carton
1	034558	Left foam end cap
1	034557	Right foam end cap
1	034559	Corrugated wrap
4	163185	Plastic foot
4	400159	#10-32 x 3/4 machine screw

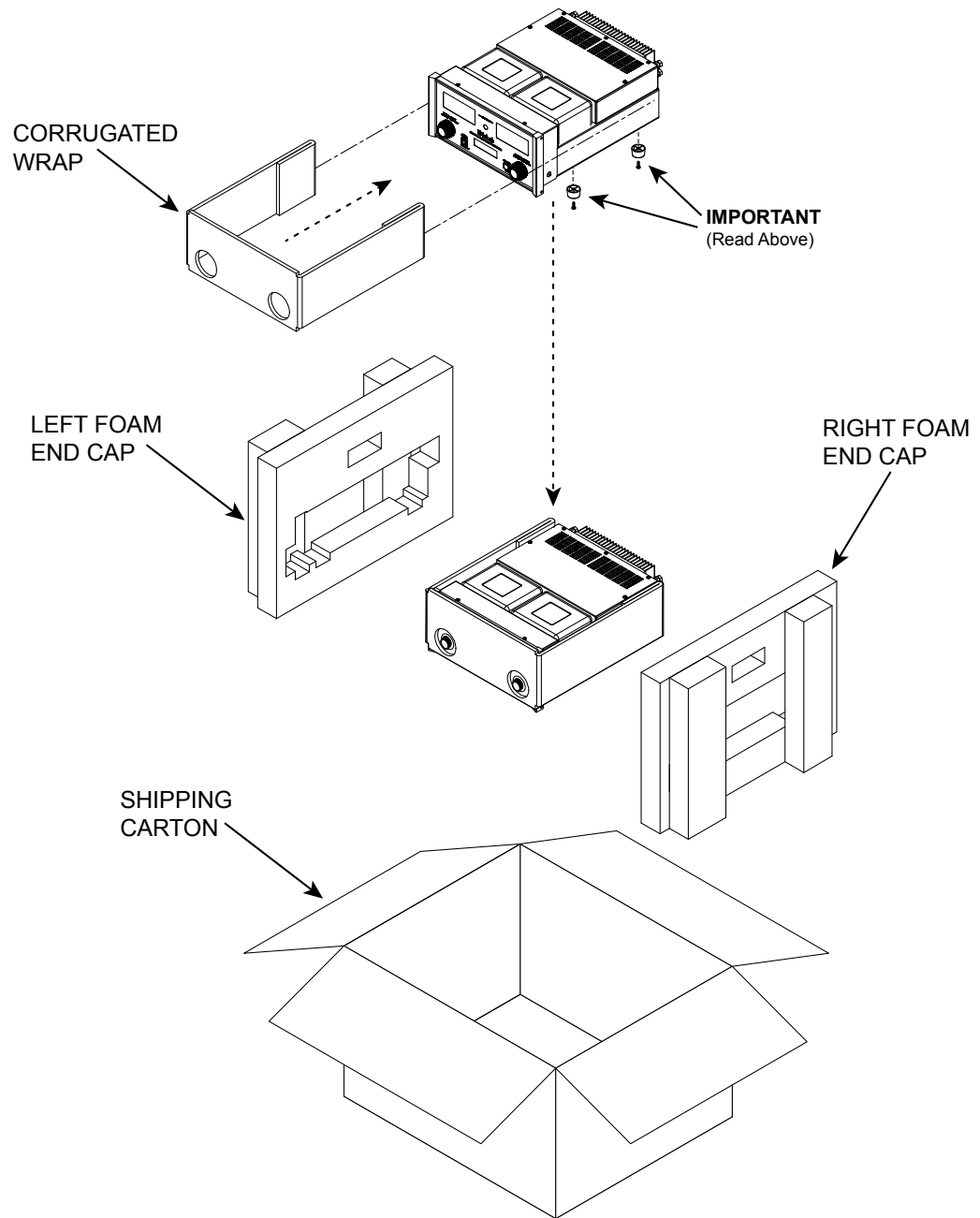



McIntosh Laboratory, Inc.  
2 Chambers Street  
Binghamton, NY 13903  
[www.mcintoshlabs.com](http://www.mcintoshlabs.com)

The continuous improvement of its products is the policy of McIntosh Laboratory Incorporated who reserve the right to improve design without notice.  
Printed in the U.S.A.